

USER MANUAL

Published March 2017

Firmware Version THD1-58



ZAXCOM.COM

TRXLT3

Don't Let The Size Fool You

TRXLT3 TRANSMITTER.....	4
HOME SCREEN	6
MAIN MENU	7
MICROPHONE GAIN SET	7
UHF TRANSMIT FREQUENCY SET	7
TRANSMITTER LOCK PAGE	7
SUB MENUS	8
MENU GROUPS	8
ACCESSING AND NAVIGATING THE MENU GROUPS	8
ENTERING AND NAVIGATING A SUB MENU	8
EXITING THE EXTENDED MENU	8
TIME CODE MENU.....	9
TIME CODE FRAME RATE SET	9
TIME CODE SOURCE SELECT.....	9
TC JAM MODE SELECT	9
MUTE TIME CODE TRANSMISSION UNTIL JAMMED	10
AUTO FRAME RATE ENABLE.....	10
TRANSMIT MENU.....	11
UHF TRANSMITTER POWER LEVEL SET	11
UHF TRANSMIT MODULATION SET.....	11
TRANSMITTER DISABLE - RECORD ONLY MODE.....	11
RECORD MENU	12
SD CARD FORMAT	12
PLAYBACK CONTROL.....	12
TIME LEFT ON CARD.....	13
AUTOMATIC RECORD AFTER BOOT UP.....	13
RECORDING MODE SET.....	13
LOW BATTERY STOP SET	13
ZAXNET MENU	14
ZAXNET MODE	14
ZAXNET RECEIVE FREQUENCY SET.....	14
ZAXNET TRANSMIT FREQUENCY SET.....	14
GROUP CODE SET.....	15
UNIT CODE SET.....	15
ZAXNET VOTING ENABLE	15
ZAXNET RECEIVE BEFORE TRANSMIT TIME	16
IFB RECEIVE PULSE SET	17
RECORD BEEP SET.....	17
AUDIO MENU.....	18
HIGH PASS FILTER.....	18
2K NOTCH FILTER.....	18
DYNAMICS	19

SETUP MENU20

- TEST TONE20
- BATTERY TYPE SET20
- KEY LOCK ON BOOT UP20
- QRX / ERX FIRMWARE UPDATE21
- LOW BATTERY STOP21
- OLED BRIGHTNESS ADJUST21
- OLED DISPLAY DIM21
- INVERT DISPLAY.....21
- INFORMATION PAGE22
- HIDE ENCRYPTION MENU.....22
- ENCRYPTION CODE SET22
- HIDE TRANSMITTER NAME MENU22
- TRANSMITTER NAME SET23
- RECORDING FORMAT24

FIRMWARE25

- UPDATING THE TRXLT3 FIRMWARE25
- UPDATING ERX FIRMWARE WITH A TRX TRANSMITTER25
- UPDATING QRX FIRMWARE WITH A TRX TRANSMITTER26

INPUTTING AUDIO27

RECOMMENDED MICROPHONES27

WIRING DIAGRAMS.....27

- TWO WIRE MICROPHONE CONFIGURATION27
- THREE WIRE MICROPHONE CONFIGURATION27
- STEREO MICROPHONE CONFIGURATION – FOR TRXLAS28
- BALANCED LINE LEVEL AND TIME CODE INPUT28
- STEREO LINE LEVEL – FOR STEREO TRANSMITTERS28

OPERATING FREQUENCIES.....29

- ZAXNET - REMOTE CONTROL AND TIME CODE29
- UHF - AUDIO29

PRODUCT SUPPORT31

SPECIFICATIONS32

ZAXCOM WARRANTY POLICY AND LIMITATIONS.....33

TRXLT3 Transmitter



1. SSMA Antenna Connector
2. OLED Display
3. Card Key
4. Microphone Input Connector (3 Pin Lemo)
5. INC / Record Key
 - Increases the parameters of a menu item.
 - When in the home screen pressing INC with the CARD key will put the transmitter into record.
 - When in the transport control screen while not recording will cause the transmitter to playback.
 - Pressing while playing back will advance playback, multiple presses will cause playback to advance in larger increments.
 - Press and hold while in the transport control screen will advance to the next segment.
 - Press it while in the home screen will display the group and unit code and the time left on the card.
6. DEC / Stop Key
 - Decreases the parameters of the menu items.
 - When in the home screen pressing DEC with the CARD key will stop the recording.
 - When playing back in the transport control screen will cause the transmitter to stop playback.
 - Press and hold while in the transport control screen will jump back to the previous segment.
 - Pressing it three times quickly while in the home screen will access the sub menu.
7. Menu / Play Key
 - Press it to access the next menu item.
 - Press it with the CARD key to playback a segment.

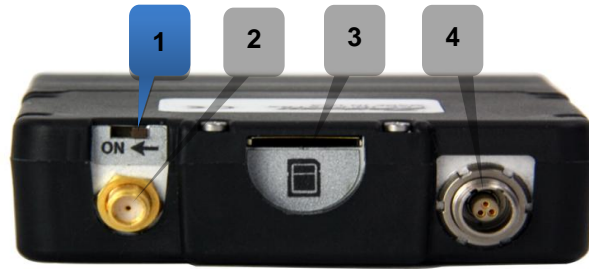

1. Power Switch
2. SSMA Antenna Connection
3. Media Slot

Inserting a Micro SD card:

With the OLED screen of the transmitter facing you, turn the card so the finger contacts are facing you and pointing down toward the slot. Insert the card into the slot and press it down until you hear a slight click. To remove it, press the card in until you hear the same click again.

4. Microphone / Input connector (3 pin Lemo)

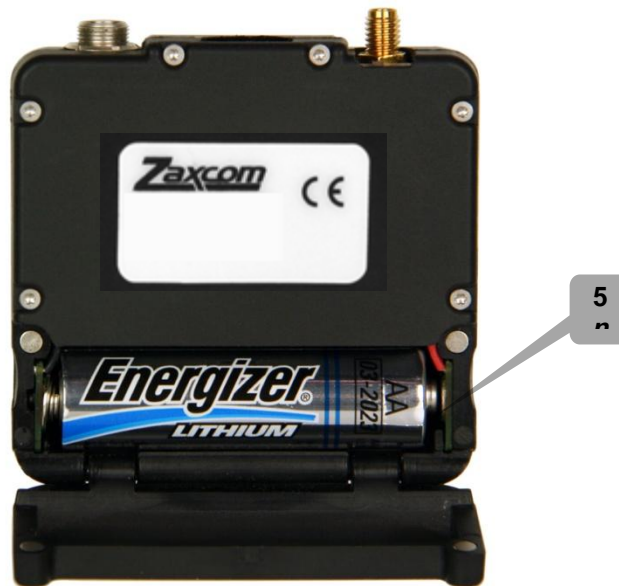

5. Battery Compartment
TRXLT3 uses 1 AA battery. Alkaline, Lithium or NiMH batteries can be used.

Home Screen

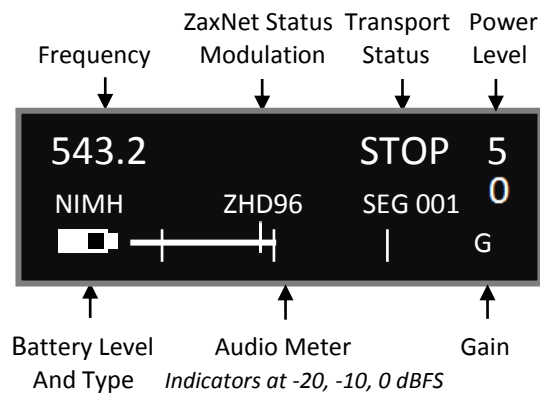

Frequency - This is the transmit frequency of the TRXLT3.

If the TRXLT3 is being used in RECORD ONLY mode "NOTX" will be displayed.

ZaxNet Status

- IFB RX - The TRXLT3 is receiving ZaxNet.
- IFB TX - The TRXLT3 is transmitting ZaxNet.

Transport Status – Displays the current mode of the recording feature.

- STOP - Recording / Playback is stopped
- LREC - TRXLT3 is recording in LOOP RECORD mode.
- REC - TRXLT3 is recording in NON-LOOP RECORD mode.
- PLAY - TRXLT3 is playing back a recorded audio file.

Power Level - Displays the transmit power level.

Battery - This displays the selected battery chemistry type as well as a battery meter which shows an approximate percentage of remaining power.

Audio Meter - Displays the modulation of the inputted audio signal.

If using a stereo transmitter in stereo mode both the left and right audio levels will be shown.

SEG - Displays the number of recorded segments on the micro SD card. Please note that regardless of the size of the card it is limited to 500 segments.

Gain - "G" Appears when the transmitter is receiving change of gain commands via ZaxNet.

Group and Unit Code - Pressing the INC key while in the home screen will display the group and unit code and the record time remaining on the card.

GROUP:1 UNIT:1
TIME LEFT 24H

Time Code and Frame Rate - Pressing the DEC key while in the home screen will display the time code and frame rate of the time code generator.

TC: 09:18:05:00
23.98 (AUTO)

Main Menu

To cycle through the main menu press the MENU key.

Microphone Gain Set

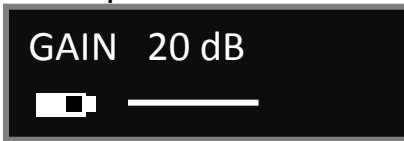

The microphone gain is adjusted from this menu. This menu displays the gain setting in decibels and a meter indicating the audio signal. The meter is displayed horizontally from left to right. In the case of a TRXLT3 S operating in stereo mode, two meters will be displayed - one for each channel. Please note that the gain in stereo mode is applied to both sources simultaneously.

UHF Transmit Frequency Set

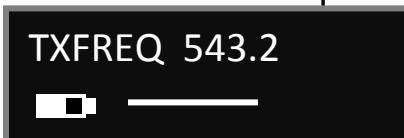

This menu is where the UHF transmit frequency is set.

- Short presses of the INC or DEC key causes the value to change by 0.1 MHz
- Holding the INC or DEC key causes the value to change by 0.5 MHz

Transmitter Lock Page



← Countdown clock starting at 5 seconds



← After the transmitter locks

This page enables a key lock function.

When a transmitter is locked the front keys will not be operational, this is to prevent any accidental key presses. Pressing the INC and DEC key when the transmitter is locked will display additional information. When the lock page is landed on a countdown clock will begin. After 5 seconds the transmitter will lock and the display will indicate that it is LOCKED followed by some of the transmitters parameters.

If the screen is exited before the 5 seconds is up the transmitter will not lock.

To lock the transmitter before the 5 seconds press and hold the DEC key

If the OLED brightness setting is set to "2" the screen will blank out when the transmitter is locked. The only thing that will be displayed is a small character displaying the status of the internal recorder.

S - The recorder is stopped, R - The transmitter is recording, L - The transmitter is recording in loop mode and P - The recorder is playing back.

To unlock the transmitter

- Simultaneously press the MENU and INC keys 5 times.
- Or
- Powering down and reboot the transmitter.

Sub Menus

Menu groups

The TRXLT3 has six sub menu groups

- **Time Code** - Changes the time code parameters of transmitter.
- **Transmit** - Changes the parameters of the UHF transmitter.
- **Record** - Changes the parameters of the on-board recorder.
- **ZaxNet** - Changes the parameters of the ZaxNet transceiver.
- **Audio** - Changes the parameters of the transmitted and recorded audio.
- **Setup** - Changes the parameters of the general operation on the transmitter.

Accessing and navigating the menu groups

From in the home screen press the CARD key three times, or hold the MENU key while booting up, to access the six menu groups. Then pressing the INC or DEC key will cycle between the menu items.

Entering and navigating a sub menu

When landing on the desired menu group press the MENU key to enter that menu.

To return to the top of the menu press the MENU key to cycle to the top or press and hold the MENU key for 1.5 seconds.

Exiting the extended menu

Press the CARD key three times quickly. Or press the MENU key to cycle through the sub menu items until HOME MENU is displayed then press the MENU key. Or cycle the power.

TIME CODE MENU

Time Code Frame Rate Set

TIMECODE 23.98
GEN 09:18:05:02

The time code frame rate menu is where the time code frame rate is set. The TRXLT3 will lock to and record all standard time code frame rates.

- 23.98, 24, 25, 29.97DF, 30 DF, 30 NDF

Time Code Source Select

TC SOURCE:
ZAXNET (RF)

The time code source menu selects how the transmitter will receive its time code.

- **ZAXNET (RF)** - The TRXLT3 will receive time code via ZaxNet from a Nomad, a QRX235, IFB100/200, TRX900CL or another TRX transmitter or a ZFR recorder that is transmitting ZaxNet time code.
- **AUDIO INPUT** - The TRXLT3, with a proper cable, will receive time code via the microphone input. When time code is connected, it takes the TRXLA approximately three seconds to recognize the TC. The screen will display TIME CODE followed by JAM when it is recognized. Please note that when using the microphone input connector, the audio level of the time code signal needs to be between -30 and -10 dBFS on the unit's meter. Any level above -10 may cause clipping, which will prevent proper reading of time code.

TC Jam Mode Select

TC JAM MODE:
AUTO-JAM NORMAL

This menu controls if the TRXLT3 will go into record when it receives a record run time code.

- **AUTO-JAM NORMAL** - The TRXLT3 will continuously jam time code via ZaxNet and will go into record when receiving a record command via ZaxNet or if the unit is put into record manually by pressing the CARD and INC keys simultaneously.
- **AUTO-LOAD REC RUN** - In Auto-Load mode the TRXLT3 will go into record when it detects rolling time code, and will stop when the time code stops. If time code is lost because the IFB signal is too weak the unit will not stop but will continue in whatever state it was in until the time code signal is restored.

Mute Time Code Transmission Until Jammed

**MUTE TC SEND
UNTIL JAMED: OFF**

If the mute time code menu is set to ON the ZaxNet transmitter will not broadcast time code over ZaxNet until the transmitter receives time code and jams its own internal time code generator. This prevents the ZaxNet from sending incorrect time code to another device.

Auto Frame Rate Enable

**AUTO FRAME RATE
ON (23.98)**

When turned ON the TRXLT3 will automatically set its frame rate to the frame rate that is being transmitted from the ZaxNet transmitter that is feeding the TRXLT3. If auto frame rate is set to OFF the frame rate will need to be adjusted manually. Please note that auto frame rate will only work when the time code is being received over ZaxNet and will not work when time code is being received via the audio input.

TRANSMIT MENU

UHF Transmitter Power Level Set

TX POWER: 50MW

The UHF transmit power of the TRXLT3 is set from this page. The transmit power can be adjusted to output 25 or 50mW. The higher the power setting the more battery power will be required.

UHF Transmit Modulation Set

**TX FORMAT:
ZHD96
PRESS CARD TO REBOOT**

The UHF transmission modulation is the way the TRXLT3 sends audio to the receiver. The modulation format is set from this menu. Please note if the transmission format that is set here, and the format set on the receiver do not match, the receiver will be unable to decode the audio from the transmitter. Also note that after any change to the transmit format the TRXLT3 will need to be rebooted by pressing the card key before the new format takes effect.

	STEREO	MONO	XR	ZHD 96	ZHD 48
Modulation Bandwidth	200 kHz	200 kHz	200 kHz	96 kHz	48 kHz
Minimum Channel to Channel Spacing	400 kHz	400 kHz	400 kHz	200 kHz*	100 kHz**
6 MHz TV Channel Capacity	15	15	15	30	60
Latency	6ms	3.5ms	6ms	6ms	18ms
Compatibility with a 200 Series Receiver	2 Transmitters	2 Transmitters	2 Transmitters	2 Transmitters	1 Transmitter
Compatibility with a 300-96 Receiver	NO	NO	NO	1 Transmitter	1 Transmitter
Compatibility with a 300-48 Receiver	NO	NO	NO	NO	1 Transmitter

* When used with a QRX300-96 receiver – the minimum spacing is 300 kHz when using all other receivers.

**When used with a QRX300-48 receiver – the minimum spacing is 200 kHz when using all other receivers.

Transmitter Disable - Record only mode

**TX DISABLE :
NORMAL TX MODE**

- **Record Only Mode** - Will set the TRXLT3 to act as a standalone recorder and will not transmit any audio over UHF. This will conserve battery power since the transmitter is disabled.
- **Normal TX Mode** - Will allow the TRXLT3 to both transmit audio and record on its internal SD card.

RECORD MENU

SD Card Format

This menu will only appear if a card was inserted prior to booting up



PRESS UP KEY 5X:
TO ERASE CARD

The Micro SD card is erased and formatted from this menu. Please note that all cards need to be formatted in a 3 series transmitter prior to recording.

Before formatting the card, the transmitter can optionally be renamed (see set up menu). When a transmitter is named that name is included in the recorded file names. By naming the transmitter it makes it easier to differentiate files from different recorders, so for example the card can be identified with the talents name, or any other unique identifier. The card name menu is located at the end of the set up menu. The factory default name is the transmitter's serial number.

Partial Format

If the card's FAT32 file structure gets corrupt while doing a file transfer, and the card is no longer recognized by the transmitter or by ZaxConvert, a partial format can be done. The partial format rewrites the FAT32 file structure and leaves the recorded audio untouched. To do a partial format from this menu press the DEC key 9 times "PARTIAL FORMAT" will then be displayed.

Playback Control

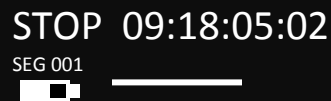

STOP 09:18:05:02
SEG 001

Recorded files can be played back from this page.

The top line displays the current mode of the recorder: REC, PLAY or STOP followed by the time code.

The bottom line contains the current segment number and the audio level.

Playing back from the transport page:

- Pressing the INC key while stopped will play the segment number that is displayed.
- Pressing the DEC key while playing back will stop the playback.
- Pressing the DEC key while stopped will jump back.
- Holding the INC key will jump ahead one segment.
- Holding the DEC key will jump back one segment.
- Pressing the INC key while in play mode will cause the playback to jump ahead, repeated quick presses will cause playback to advance in larger increments.

Time Left on Card

This menu will only appear if a card was inserted prior to booting up

TIME LEFT 20 H
TIME USED 4 H

This page displays the remaining record time left on the card as well as the time already recorded on the card.

Automatic Record after Boot up

RECORD ON BOOTUP
OFF

Record on boot up allows the onboard recorder to automatically start recording after the transmitter boots up.

- **ON** - The onboard recorder will automatically start to record after the TRXLT3 boots up.
- **OFF** - The onboard recorder will wait for a ZaxNet command or a manual record trigger to start recording.

Recording Mode Set

RECORD MODE:
LOOP RECORD

Record mode sets what the recorder will do after the card is full. Regardless of this setting the card can only record 500 files.

- **NON-LOOP RECORD** - Once the card is full the recording will stop and FULL will be displayed. This setting prevents over-writing any portion of the audio.
- **LOOP RECORD** - Once the card is full, the new audio will begin over-writing the oldest audio on the card.

Low Battery Stop Set

LOW BATT STOP:
NEVER STOP

Low battery stop will set the amount of time, after a low battery warning occurs, the on-board recorder will close the current file and stop recording.

This is to prevent possible file corruption if the unit constantly powers off and on due to a dead battery.

- **NEVER STOP** - The onboard recorder will not stop recording unless it is manually stopped by a key press, or when it receives a stop command via ZaxNet or if the battery dies.
- **Any interval from 1 to 99 minutes** - Once the battery indicator starts blink a low battery warning the onboard recorder will continue to record for the time set here - then it will close the file and stop recording.

ZAXNET MENU

ZaxNet Mode

ZAXNET MODE: TX

This menu sets the mode of the ZaxNet transceiver.

- **OFF** - The ZaxNet transceiver is disabled. The TRXLT3 will not receive ZaxNet commands or time code and it will not send any ZaxNet audio. Please note if ZaxNet mode is set to OFF the several ZaxNet menu items will not appear.
- **RX** - The ZaxNet transceiver will receive ZaxNet commands and time code. This screen will display what ZaxNet data is being received by the TRXLT3. Including total received information packets, ZaxNet TC received and remote control commands received. This information is used for debugging purposes.
- **TX** - The ZaxNet transceiver will send ZaxNet confidence audio and time code. Please note that in ZHD48 mode the TRXLT3 will not be able to go into transmit mode.

ZaxNet Receive Frequency Set

This menu will only appear if the TRXLT3 is set to receive (RX) mode

RX FREQ : 2.403 RX
SIGNAL : 28 |

The ZaxNet receive frequency is the frequency that the TRXLT3 will get its wireless time code and remote control commands on. This frequency will need to match the frequency of the corresponding ZaxNet transmitter. The ZaxNet transmitter can be a QRX with QIFB, Nomad, TRX900CL or IFB100/200. The TRXLT3 can also receive ZaxNet time code from another TRX transmitter or a ZFR recorder that is transmitting ZaxNet on this frequency. Please keep in mind that the range will be limited when receiving ZaxNet from a TRX or ZFR. When the TRXLT3 is receiving a valid ZaxNet signal the signal strength will be shown as well as signal strength meter that runs vertically on the far right side of the screen.

ZaxNet Transmit Frequency Set

This menu will only appear if the TRXLT3 is set to transmit (TX) mode

ZAXNET TX FREQ:
2.473

The ZaxNet transmit frequency is the frequency that the ZaxNet transmitter on the TRXLT3 will broadcast time code and confidence audio on. Please note the ZaxNet transmitted audio is for quality control purposes and the expected range will be less than 20 feet.

Group Code Set

**REMOTE CONTROL
GROUP CODE = 1**

This menu is where the TRXLT3 is assigned to a group. The group code allows transmitters to be grouped together so they can be controlled via ZaxNet without affecting others.

So for example a TRXLT3 set to Group 1 will be controlled by a ZaxNet transmitter set to Group 1 and a TRXLT3 assigned to group 2 will be controlled by a Group 2 ZaxNet transmitter. This is helpful if two or more people on set are sending ZaxNet commands. Therefore the different group codes allow each person to be independent and not interfere with each other. Most users leave the group set to 1 on all of their Zaxcom products. Group codes can be set from 1 to 99.

Unit Code Set

**REMOTE CONTROL
UNIT CODE = 001**

This menu is where the TRXLT3 is assigned a unit code. The unit code is a unique number used to identify each TRXLT3 within a particular group. This allows individual transmitters within the same group to be independently controlled. Each transmitter should have a different unit code.

Unit codes can be assigned any number from 1 to 200.

ZaxNet Voting Enable

This menu will only appear if the TRXLT3 is set to receive (RX) mode

**ZAXNET VOTING:
NORMAL (OFF)**

The purpose of voting is to allow the ZaxNet receiver in the TRXLT3 to choose, and switch to, the stronger signal from two different ZaxNet transmitters. One purpose of this is if on a large set a second IFB transmitter can be placed at a different location so the ZaxNet receiver in the TRXLT3 can choose the stronger signal. Please note that the second ZaxNet transmitting frequency must be set 2MHz higher than the first ZaxNet transmitter.

ZaxNet Receive Before Transmit Time

**RX TO TX TIME:
OFF (NORMAL RX)**

Receive only mode.

← The ZaxNet transceiver will only receive ZaxNet and NOT go into transmit mode. Therefore no ZaxNet TC and/or audio will be transmitted. This setting shuts off the ZaxNet transmitter.

**ZAXNET RX TO TX:
0 SEC: TX ONLY**

Transmit only mode.

← The ZaxNet transceiver will only transmit ZaxNet TC and audio and will NOT receive wireless TC or ZaxNet commands. This setting shuts off the ZaxNet receiver.

**ZAXNET RX TO TX:
20 SEC**

Receive then Transmit mode.

← After boot up the ZaxNet transceiver will search for a ZaxNet signal for the selected time so it can receive and lock time code before it begins to transmit TC and confidence audio.

This menu adjusts the state of the ZaxNet transceiver. This also sets how long after boot-up up the TRXLT3 will search for ZaxNet time code before it begins transmitting its audio over ZaxNet for monitoring purposes. This is so the TRX3LA can lock to ZaxNet time code source before the unit will send confidence audio over ZaxNet.

IFB Receive Pulse Set

This menu will only appear if the TRXLT3 is set to go into transmit in the RX to TX Time menu.

ZAXNET RX PULSE:
OFF

← The ZaxNet transceiver will stay in transmit mode and never go into receive mode.

IFB RX PULSE
600 SECS

← In this example the ZaxNet transceiver will go out of transmit mode every 10 minutes. This setting would be used so the TRX could update its time code while monitoring audio via an ERX receiver.

This menu sets the interval that the ZaxNet transceiver will stop sending confidence audio and search for time code.

When enabled the pulse setting tells the ZaxNet transceiver to leave ZaxNet transmit mode once every XXX seconds and go into receive mode so it can re-jam its time code wirelessly via ZaxNet. This setting would be used so the TRXLT3 could update its time code while monitoring audio via an ERX receiver. Please note when the ZaxNet transceiver searches for ZaxNet it will temporarily go out of transmit mode for approximately 1 second as it searches for ZaxNet time code. The settings are NEVER or any interval between 5 and 999 seconds.

Record Beep Set

This menu will only appear if the TRXLT3 is set to transmit (TX) mode

ZNET RECORD BEEP
OFF

When the record beep is set to ON, and the TRXLT3 is recording, the confidence audio sent to the ERX via ZaxNet will have an audible beep, in variable intervals, giving conformation that the TRXLT3 is indeed recording. The beeps will only be heard in the ERX and will not be recorded on the card, or be sent to the UHF receiver. The intervals can be set between 2 to 18 seconds in 2 second increments.

AUDIO MENU

High Pass Filter

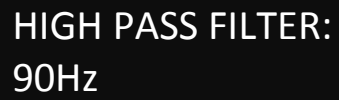

HIGH PASS FILTER:
90Hz

The high pass filter is turned on and adjusted from this menu.
The high pass filter range is 70Hz to 220Hz in 10Hz increments.

2K Notch Filter



2K NOTCH FILTER
ON

The 2K notch filter is useful in removing digital RF interference that can be introduced into some microphones.

Dynamics

DYNAMICS

The dynamics is a soft knee compressor that is located after the analog to digital converter which will limit the dynamic range to prevent clipping during occurrences of loud audio. Dynamics is comprised of both a compressor and an expander, which operate jointly. The compressor in the dynamics can set to mild or extreme compression and features a soft knee for more transparent operation.

To enter the Dynamics Menu

Press the INC or DEC key - "PARMS" (parameters) will be displayed on the right.

To move to the next parameter, press the MENU key.

To exit this page, hold the MENU key for 1 second.

Dynamics Parameters

- **Link L-R:** OFF / ON: If using a stereo LT3 transmitter this links the left and right signal so if one side of the signal needs compressing / expansion the other side will do the same to match.
- **SPEED** (Decay Speed) : SLOWEST / SLOW / NORMAL / FAST / FASTEST
Sets how gradual the signal level decreases after a signal reaches the threshold setting. This is typically set to FAST.
- **ATTACK** (Attack Speed) : SLOWEST / SLOW / NORMAL / FAST / FASTEST
Sets the speed in how fast the gain is reduced once the signal exceeds the threshold setting. This is typically set to FAST.
- **CMP RATIO** (Compressor Ratio): Valid range: 1.0: to 5.0:1, in 0.1 steps.
The amount of gain reduction is determined by the compressor ratio setting.
A compressor ratio for example of 2.0:1 means for every 1 dB above the compressor threshold the gain will be reduced 2dB. A higher ratio setting makes the compressor more aggressive.
- **CMP THRESH** (Compressor Threshold): Valid range: 0 to -96dB, in 1dB steps.
This sets the level in which gain reduction occurs.
- **CMP KNEE:** (Compressor Soft Knee): Valid range: 0 to 20dB, In 1dB steps.
Sets the compressor's soft knee. A soft knee reduces "softens" the audible change from uncompressed to compressed, this is useful especially for higher ratios where the changeover is more noticeable
- **EXP RATIO** (Expansion Ratio): Valid range: 1:1.00 to 1:4.00, In 0.01 steps
Sets the expansion ratio. For example a 1:2.0 expansion ratio means for every 1 dB below the expansion threshold the gain will be reduced 2dB.
- **EXP THRESH** (Expansion Threshold): Valid range: 0 to -96dB, in 1dB steps.
Sets the threshold above which gain reduction occurs.
- **REDUCE** (Expander Gain Reduction): Valid range: 0 to -36dB, in 1dB steps.
This sets the limit on the amount of gain reduction caused by the expander.
- **GAIN** (Make-up Gain): Valid range: 0 to 30dB, In 1dB steps.
Gain is used to compensate for the gain reduction caused by the compressor. Because the compressor is reducing the gain (or level) of the signal, the ability to add a fixed amount of make-up gain at the output is provided so that an optimum level can be reached.

SETUP MENU

Test Tone

TEST TONE: ON
| | |

The TRXLT3 has an internal tone generator which will generate tone so the signal chain can be properly gain staged. From this menu pressing the INC key will turn on the tone generator and cycle through the tone options which are 500Hz at -20dBFS, 1000Hz at -20dBFS or 500Hz at full scale.

Battery Type Set

BATTERY TYPE:
 LITHIUM QRX

This menu is where the TRXLT3 battery type is set so the receiver can properly display the remaining battery capacity. The settings are NIMH, Lithium and Alkaline (Displayed as “ - - -”). There is also an option for “ENG” and “QRX” – this is to accommodate different Zaxcom receiver models (“ENG” RX900) or (“QRX” QRX).

Standby Mode After Boot Up

STANDBY BOOT MODE
NORMAL MODE

This menu sets what power mode the TRXLT3 boots up to.

- **NORMAL MODE** - The transmitter will boot up normally.
- **STANDBY MODE** - The transmitter boots up in low power standby mode. The transmitter will be waiting for a manual press the of the MENU key to come up to full power.
- **REMOTE STANDBY** - The transmitter boots up in low power standby mode. The transmitter will be waiting for a ZaxNet “WAKE” command to come up to full power.

Key Lock On Boot Up

KEY LOCK ON BOOT:
UNLOCKED

This menu sets what happens to the keys on the face of the TRXLT3 after boot-up.

- **LOCKED** - After boot-up has completed, the transmitter will automatically go into lock mode and the keys will be locked to prevent accidental changes to the settings.
- **UNLOCKED** - After boot-up the keys will remain unlocked. In unlocked mode the keys can still be locked going in to the lock screen in the main menu and wait 5 seconds.

To unlock the keys at any time - simultaneously press the MENU and INC key 5 times.

QRX / ERX Firmware Update

PRESS ↑ TO SEND
QRX PROG FILE

This page is used to update the firmware on a QRX or ERX receiver.

If the ZaxNet mode is set to OFF or receive (RX) this menu will allow for QRX firmware to be updated - if the ZaxNet mode is set to transmit (TX) then this menu will allow for ERX to be updated.

For complete update instructions see the FIRMWARE section in the back of this manual.

Low Battery Stop

LOW BATT STOP:
NEVER STOP

Low battery stop will set the amount of time, after a low battery warning occurs, the on-board recorder will close the current file and stop recording.

This is to prevent possible file corruption if the unit constantly powers off and on due to a dead battery.

- **NEVER STOP** - The onboard recorder will not stop recording unless it is manually stopped by a key press, or when it receives a stop command via ZaxNet or if the battery dies.
- **Any interval from 1 to 99 minutes** - Once the battery indicator starts blink a low battery warning the onboard recorder will continue to record for the time set here - then it will close the file and stop recording.

OLED Brightness Adjust

OLED BRIGHTNESS:
3

This setting adjusts the brightness of the OLED display. The brightness can be set from 0 to 3 with 3 being the brightest and 0 the dimmest. Number 2 allows for blanking the lock screen so when the transmitter is locked the only thing that will be displayed is a single small character displaying the status of the internal recorder.

OLED Display Dim

DISPLAY DIM:
OFF (NORMAL)

This setting adjusts the amount of time, after the last key press, that the OLED display will dim. The dim time can be set to OFF in which the display will remain bright or any interval from 1 to 60 seconds.

Invert Display

INVERT DISPLAY:
OFF

Turning on inverted display will cause the OLED to display black characters on a white background.

Information Page

```

--- INFO ---
FIRMWARE   V1-06
SN: 1234   DSP:1B (ZHD)
OPT = 03
  
```

This page displays the current firmware version, the serial number, the DSP version, and the option code to tell if the TRXLT3 is a stereo unit. If the TRXLT3 is a stereo version the option code will be 07, a non-stereo transmitter will display option code 03.

Hide Encryption Menu

```

ENCRYPTION MENU:
ON
  
```

This setting will hide the encryption menu. A hidden encryption menu allows for quicker navigation and prevents accidental changes.

- **HIDDEN** - The encryption menu doesn't appear when cycling through the menu settings.
- **DISPLAYED** - The encryption menu will appear.

Encryption Code Set

```

ID1: 000 ID2: 000
                ↑
  
```

If an encryption code is set the transmitted audio will be encrypted and can only be listened to if the receiver has the matching encryption code entered. When receiving an audio signal and the codes do not match, all that will be heard is white-noise or silence. So if using encryption it is important to make sure the matching receiver has the same code.

These two sets of numbers are formed into a single six-digit encryption code which provides a total of 16,777,216 possible combinations.

Please note that both of these codes should be set to 000 for normal un-encrypted operations

Adjusting the encryption code

1. Momentarily press the MENU key to advance to the next character.
2. To change the designated character, press the INC or DEC key.
3. To exit this page, press and hold the MENU key for 1 second.

Hide Transmitter Name Menu

```

NAME MENU:
ON
  
```

This setting will hide the name menu. A hidden name menu allows for quicker navigation and prevents accidental changes.

- **HIDDEN** - The name menu doesn't appear when cycling through the menu settings.
- **DISPLAYED** - The name menu will appear.

Transmitter Name Set



The transmitter name menu allows the transmitter to be named to be changed from the default name - which is the unit's serial number. The name entered becomes part of the name of the recorded audio files, and is also included in the metadata of the BWF file. Naming the unit aids in identifying the files from several different recorders.

The maximum name length is 8 characters. Any letter or number can be used. If desired a space can even be used.

To set/change the transmitter name:

1. Press the INC or DEC key to change the character in the current position above the arrow.
2. Press the MENU key to proceed to the next character.
3. When finished, press and hold the MENU key to set the name.

Media

While any size card will work in the TRXLT3 transmitter we recommend using a 4GB Micro SD card. We also recommend only buying a brand name card such as Transcend, SanDisk. And very importantly please buy all cards from a reputable dealer because counterfeit cards exist and can cause recording issues. We also highly recommend that the all cards are tested before taking them out into the field. Here is a simple testing procedure to determine if the card will function correctly:

1. Format the card in the transmitter.
2. Power cycle the transmitter.
3. Record at least 20 minutes of audio to the card with no time code source.
4. Look at the Main Screen it should still be recording in segment #1.
5. Playback and listen to the file.

Media Capacity

The TRXLT3 can use Micro SD cards, up to 16 GB. While any size card will work we recommend using 4GB cards. All cards that are used in the TRXLT3 must be formatted in a 3 series transmitter to work properly, cards formatted in any other series transmitter will not record properly. Please note that regardless of the size of the card the onboard recorder will only be able to record up to 500 individual segments on any given card.

Available recording times depend on the selected modulation and are as follows:

SD Card Size	Available Record Time Mono / Stereo	Available Record Time XR / ZHD
512 MB	3 hours	6.75 hours
1 GB	6 hours	13.5 hours
2 GB	12 hours	27 hours
4 GB	24 hours	54 hours
8 GB	48 hours	108 hours
16 GB	96 hours	216 hours

Please note the transmitter will **NOT** record onto the card if:

- The card was not inserted before the TRX booted up.
- If the card was removed while the power was on.
- If LOW BATTERY is being displayed.

Recording Format

The media card is formatted using a FAT32 file system. While recording, the unit places all recorded audio in a single file on the media. The files generated by the recorder (.zax format) can only be recognized by Zaxcom's ZaxConvert program. Using ZaxConvert will transfer the file to a Broadcast Wave or MP3 file. ZaxConvert is available to anyone for free from the Zaxcom website <http://www.zaxcom.com/firmware-updates>

Firmware

Each unit is shipped with the latest firmware version installed. As newer firmware becomes available it can be downloaded from the Zaxcom website:

<http://www.zaxcom.com/firmware-updates>

Newer version of beta firmware may be found on the Zaxcom Forums:

<http://www.zaxcom.com/forum>

Each time a unit is powered up, the firmware version number is displayed briefly on the screen. Pressing the DEC key during the boot up will slow down the screen to allow easier viewing of the information.

Updating the TRXLT3 firmware

1. Set the transmission modulation to mono.
2. Format a micro SD card in the transmitter.
3. Remove the card and with a computer delete the "SNXXXX.ME" file.
4. Download the TRX firmware "THD-XXX.bin" from the Zaxcom website and copy it onto the formatted card.
5. Insert the card into the transmitter.
6. Simultaneously hold down the INC and DEC keys while powering up the unit.
7. The screen will display "BURN ROM" with the version of firmware that is loading.
8. From power up to "DONE" will take about 30 seconds.
9. Upon completion, cycle the power to run on the new version.

WARNING: Before updating the firmware be sure to insert a fresh set of batteries and do not power down the unit during the update process, if the unit should lose power during the upgrade, it may need to be sent back to Zaxcom for repair.

Updating ERX firmware with a TRX transmitter

1. From the ZaxNet menu set ZaxNet mode to transmit (TX).
2. Check that the ERX is set to the same ZaxNet frequency that the TRX is set to transmit on. Check that the GROUP ID is set the same in both the TRX and ERX, and make sure encryption is shut off.
3. Format a micro SD card in TRX transmitter.
4. Remove the card, and with a computer delete the "SNXXXX.ME" file.
5. Download the ERX firmware "ERX-XXX.bin" from the Zaxcom website and copy it onto the formatted card.
6. Insert the card into the transmitter.
7. Proceed to the SETUP MENU and select PRESS UP TO SEND ERX PROG FILE
8. From the firmware update menu on the ERX press the INC key 5 times to see WAITING FOR PROGRAM.
9. Press the INC key on the transmitter to trigger the update process.
10. The ERX should indicate its progress after a few seconds.
11. When the ERX has been updated the screen will display "SUCCESS".

WARNING: Before updating the firmware be sure to insert a fresh set of batteries and do not power down the unit during the update process, if the unit should lose power during the upgrade, it may need to be sent back to Zaxcom for repair.

Updating QRX firmware with a TRX transmitter

1. Format a micro SD card in a TRX transmitter.
2. With a computer take the formatted card and perform the following:
 - Delete the “SNXXXX.ME” file from the card.
 - Download the new QRX firmware and load it into the card. (QR2-XXX.BIN)
3. Insert the card and a fresh set of batteries into the TRX transmitter.
4. At the QRX:
 - Verify the QRX is set to single mode and modulation is set to mono.
 - Verify encryption is off (ID1 and ID0 are both set to 000)
 - Set the UHF Frequency to the same frequency as the programming transmitter.
 - The QRX receiver status LEDs should both be green.
 - From the extended menu go to the firmware update page and press the INC key.
 - The screen will display waiting for program. This indicates the receiver is ready to download the new firmware. This can be done to several QRXs so they will be updated at the same time.
5. At the transmitter proceed to the setup menu proceed to the firmware update menu (see TRX manual) and press the INC key.
6. Each QRX should indicate it is receiving the program.
7. After the firmware send cycle, all of the receivers should be re-programmed and “SUCCESS . . . REBOOT NOW” will be displayed. If there was a reception error, the affected receiver will automatically restart the process with the start of the next send cycle.
8. Reboot the QRX and verify the QRX is running the new firmware version.

WARNING: After the QRX has received its entire program, it will erase and burn its firmware into the ROM. During this process, which only takes a few seconds, you **MUST NOT** turn ‘OFF’ the QRX. If the program is never fully received, it is safe to cycle the power.

Inputting Audio

The TRXLT3 use an unbalanced microphone input via a 3-pin micro-LEMO connector. An unbalanced dynamic microphone or a powered lavalier can be used.

The TRXLT3 can also accept a line-level input, though an inline pad is required.

Recommended Microphones

Zaxcom recommends the following microphones for use with the TRXLT3:
Countryman EMW, B3, B6, Sanken COS-11D, DPA 4063

Wiring Diagrams

The following 3-pin micro-LEMO connectors mate with the microphone connector:

- FGB.00.303.CLAD.22 – has a latch with a pull release.
- FVB.00.303.NLA – has a latch with a twist release.

Please note it is required that the ground gets attached to the shell of the LEMO connector.

Two Wire Microphone Configuration

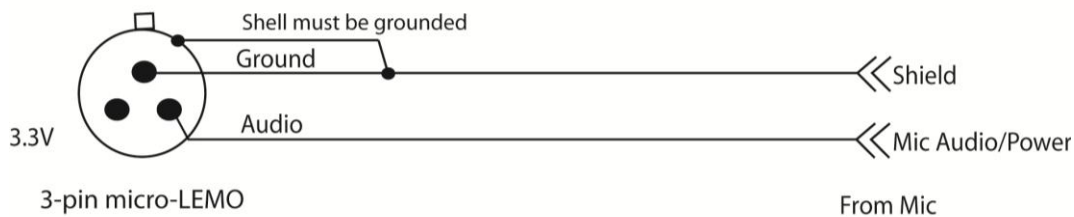

Three Wire Microphone Configuration

Please contact the microphone manufacturer.

Stereo Microphone Configuration – for TRXLAS

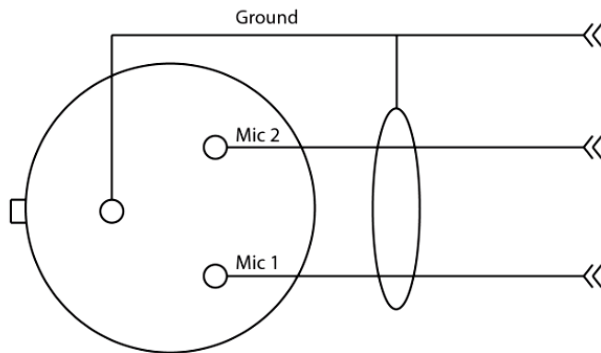

Balanced Line Level and time code Input

Mono line-level and/or timecode input

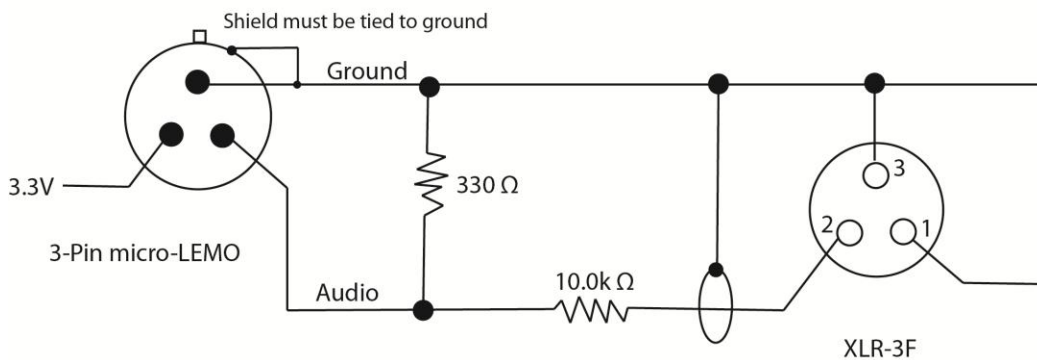

Stereo Line Level – for stereo transmitters

Stereo line-level input with pads

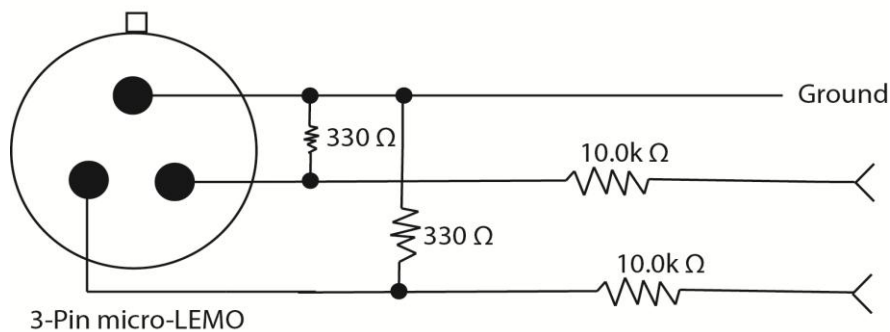

Operating Frequencies

ZaxNet - Remote Control and Time Code

2.403 to 2.475 GHz

UHF - Audio

TRXLT3.5

512.0 MHz to 614.0 MHz (Blocks 20 through 23)

TRXLT3.6

596.0 MHz to 698.0 MHz (Blocks 23 through 26)

SMA/SSMA ANTENNA CUTTING CHART

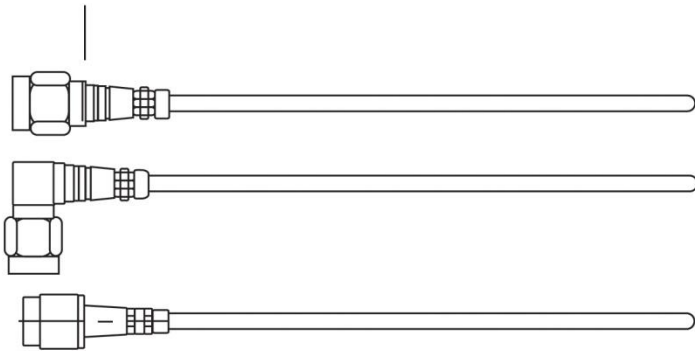
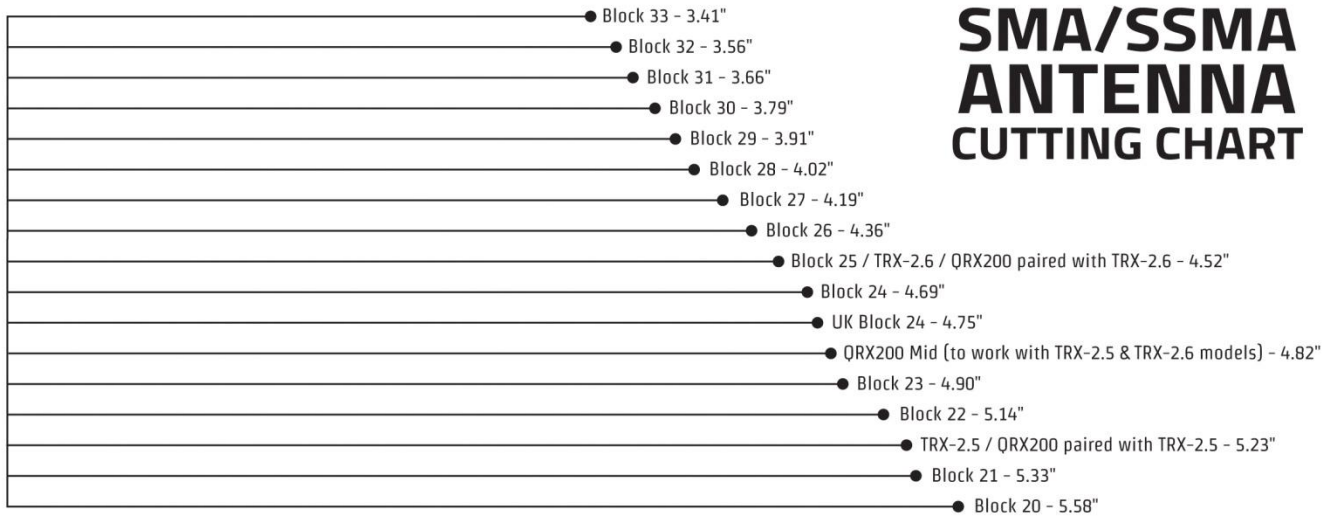

ZAXCOM

www.zaxcom.com



Product Support

- Register** your product with Zaxcom: <http://zaxcom.com/support/product-registration/>
- Download the latest **Firmware** from: <http://zaxcom.com/support/updates/>
- Download the latest **User Manuals** from: <http://zaxcom.com/support/updates/>
- Submit Technical Questions** at: <http://www.zaxcom.com/submit-a-technical-question>
- Submit information for **Repair Services** at: <http://www.zaxcom.com/support/repairs>
- Join the **Zaxcom User Forum** at: <http://www.zaxcom.com/forum/forum.php>
- Join the **Zaxcom Face Book User Group** at: <https://www.facebook.com/groups/682199065139938/>

Specifications

Transmitter

Power output: 25 / 50 mW – Firmware Selectable

RF Modulation: Proprietary Digital Method

RF Frequency Range: TRXLT3.5: 512 - 614 MHz

TRXLT3.6: 596 -698 MHz

Antenna Connector: 50 Ω SMA Female

Emission Designator: 180 KV2E

FCC Part: 75.861

Transmitter Audio

A-D Dynamic Range: 127dB

Analog distortion: 0.002%

A-D system: NeverClip Zaxcom proprietary

Frequency Response: Mode 0: 20 Hz to 16 kHz / T & M Mode 0.2 Hz to 16 kHz

Mic Power: 3.3VDC

Mic Connector: 3-Pin Micro LEMO

Mic impedance: 6.8 k Ω

ADC Bit-Depth: 24 Bits

Time code Reader/Generator

Clock Accuracy: 1.54PPM (1 Frame Out in 6 Hours)

Time code Type: SMPTE

Time code Frame Rates: 23.98, 24, 25, 29.97NDF, 29.97DF, 30NDF, 30DF

Recording

Media: Micro SD Card (Flash Memory)

File Format: .ZAX

Recording Time: Up to 216 Hours (16 GB card)

2.4 GHz ZaxNet Receiver

RF Frequency Range: 2.403 to 2.475 GHz

RF Modulation: Digital Spread Spectrum

RF Frequency Step: 0.001 GHz (1 MHz)

RF Bandwidth: 1 MHz

Channel Separation: 2 MHz

Sensitivity: -96 dBm

Physical

Weight: 3.1 oz with battery

Dimensions (H x W x D): 2.4" X 2.4" X .65"

Display: Graphic OLED

All Specifications are subject to change without notice.

Zaxcom Warranty Policy and Limitations

Zaxcom Inc. values your business and always attempts to provide you with the very best service.

No limited warranty is provided by Zaxcom unless your TRX ("Product") was purchased from an authorized distributor or authorized reseller. Distributors may sell Product to resellers who then sell Product to end users. Please see below for warranty information or obtaining service. No warranty service is provided unless the Product is returned to Zaxcom Inc. or a Zaxcom dealer in the region where the Product was first shipped by Zaxcom.

Warranty Policy

The Product carries a Standard Warranty Period of one (1) year.

NOTE: The warranty period commences from the date of delivery from the Zaxcom dealer or reseller to the end user.

There are no warranties which extend beyond the face of the Zaxcom limited warranty. Zaxcom disclaims all other warranties, express or implied, regarding the Product, including any implied warranties of merchantability, fitness for a particular purpose or non-infringement. In the United States, some laws do not allow the exclusion of the implied warranties.

Troubleshooting & Repair Services

No Product should be returned to Zaxcom without first going through some basic troubleshooting steps with the dealer you purchased your gear from.

To return a product for repair service, go to the Zaxcom Repair Services page <http://www.zaxcom.com/repairs> and fill in your information; there is no need to call the factory for an RMA. Then send your item(s) securely packed (in the original packaging or a suitable substitute) to the address that was returned on the Repair Services page. Insure the package, as we cannot be held responsible for what the shipper does.

Zaxcom will return the warranty repaired item(s) via two-day delivery within the United States at their discretion. If overnight service is required, a FedEx or UPS account number must be provided to Zaxcom to cover the shipping charges.

*Please note a great resource to troubleshoot your gear is the Zaxcom Forum: <http://www.zaxcom.com/forum>.

Warranty Limitations

Zaxcom's limited warranty provides that, subject to the following limitations, each Product will be free from defects in material and workmanship and will conform to Zaxcom's specification for the particular Product.

Limitation of Remedies

Your exclusive remedy for any defective Product is limited to the repair or replacement of the defective Product.

Zaxcom may elect which remedy or combination of remedies to provide in its sole discretion. Zaxcom shall have a reasonable time after determining that a defective Product exists to repair or replace a defective Product. Zaxcom's replacement Product under its limited warranty will be manufactured from new and serviceable used parts. Zaxcom's warranty applies to repaired or replaced Product for the balance of the applicable period of the original warranty or thirty days from the date of shipment of a repaired or replaced Product, whichever is longer.

Limitation of Damages

Zaxcom's entire liability for any defective Product shall, in no event, exceed the purchase price for the defective Product. This limitation applies even if Zaxcom cannot or does not repair or replace any defective Product and your exclusive remedy fails of its essential purpose.

No Consequential or Other Damages

Zaxcom has no liability for general, consequential, incidental or special damages. These include loss of recorded data, the cost of recovery of lost data, lost profits and the cost of the installation or removal of any Product, the installation of replacement Product, and any inspection, testing or redesign caused by any defect or by the repair or replacement of Product arising from a defect in any Product.

In the United States, some states do not allow exclusion or limitation of incidental or consequential damages, so the limitations above may not apply to you. This warranty gives you specific legal rights and you may also have other rights, which vary from state to state.

Your Use of the Product

Zaxcom will have no liability for any Product returned if Zaxcom determines that:

- The Product was stolen.
- The asserted defect:
 - Is not present,
 - Cannot reasonably be fixed because of damage occurring when the Product is in the possession of someone other than Zaxcom, or
 - Is attributable to misuse, improper installation, alteration, including removing or obliterating labels and opening or removing external covers (unless authorized to do so by Zaxcom or an authorized Service Center), accident or mishandling while in the possession of someone other than Zaxcom.
- The Product was not sold to you as new.

Additional Limitations on Warranty

Zaxcom's warranty does not cover Product, which has been received improperly packaged, altered or physically abused.

NOTICE:

Most users do not need a license to operate a wireless microphone system. Nevertheless, operating a microphone system without a license is subject to certain restrictions:

- the system may not cause harmful interference,
- it must operate at a low power level (not in excess of 50 milliwatts),
- it has no protection from interference received from any other device.

Purchasers should also be aware that the FCC is currently evaluating the use of wireless microphone systems, and these rules are subject to change. For more information, call the FCC at 1-888-CALL-FCC (TTY: 1-888-TELL-FCC) or visit the FCC's wireless microphone website at: www.fcc.gov/cgb/wirelessmicrophones. To operate wireless microphone systems transmitting with greater than 50mW of radiated power, you must qualify as a Part 74 user and be licensed.

This alert does **NOT** apply to Part 74 users

Warning: Changes or modifications to this device not expressly approved by Zaxcom Inc. could void the user's authority to operate the equipment.

NOTE: This equipment has been tested and found to comply with the limits for a Class B digital device, pursuant to Part 15 of the FCC Rules. These limits are designed to provide reasonable protection against harmful interference in a residential installation. This equipment generates, uses, and can radiate radio frequency energy and, if not installed and used in accordance with the instructions, may cause harmful interference to radio communications. However, there is no guarantee that interference will not occur in a particular installation. If this equipment does cause harmful interference to radio or television reception, which can be determined by turning the equipment off and on, the user is encouraged to try to correct the interference by one or more of the following measures:

- Reorient or relocate the receiving antenna.
- Increase the separation between the equipment and receiver.
- Connect the equipment into an outlet on a circuit different from that to which the receiver is connected.
- Consult the dealer or an experienced radio/TV technician for help.

RF Exposure:

This equipment complies with FCC radiation exposure limits set forth for an uncontrolled environment. This equipment is in direct contact with the body of the user under normal operating conditions. This transmitter must not be co-located or operating in conjunction with any other antenna or transmitter.

Under Industry Canada regulations, this radio transmitter may only operate using an antenna of a type and maximum (or lesser) gain approved for the transmitter by Industry Canada. To reduce potential radio interference to other users, the antenna type and its gain should be so chosen that the equivalent isotropically radiated power (e.i.r.p.) is not more than that necessary for successful communication.

Conformément à la réglementation d'Industrie Canada, le présent émetteur radio peut fonctionner avec une antenne d'un type et d'un gain maximal (ou inférieur) approuvé pour l'émetteur par Industrie Canada. Dans le but de réduire les risques de brouillage radioélectrique à l'intention des autres utilisateurs, il faut choisir le type d'antenne et son gain de sorte que la puissance isotrope rayonnée équivalente (p.i.r.e.) ne dépasse pas l'intensité nécessaire à l'établissement d'une communication satisfaisante.

This radio transmitter (contains the module PR6-XRT) and has been approved by Industry Canada to operate with the antenna types listed below with the maximum permissible gain and required antenna impedance for each antenna type indicated. Antenna types not included in this list, having a gain greater than the maximum gain indicated for that type, are strictly prohibited for use with this device.

Quarter Wave Whip Antenna, 5.19dBi gain, 50 Ohms

Le présent émetteur radio (PR6-XRT) a été approuvé par Industrie Canada pour fonctionner avec les types d'antenne énumérés ci-dessous et ayant un gain admissible maximal et l'impédance requise pour chaque type d'antenne. Les types d'antenne non inclus dans cette liste, ou dont le gain est supérieur au gain maximal indiqué, sont strictement interdits pour l'exploitation de l'émetteur.

Quarter Wave Whip Antenna, 5.19dBi gain, 50 Ohms

USA - FCC Part 74, FCC Identifier PR6XRT

Canada - Industry Canada RSS 210, IC:12755A-XRT

Zaxcom Digital Wireless are protected under following patent #'s:
4,327,066 / 7,711,443 / 7,929,902 / 8,385,814 / 8,878,708 / 8,842,854



Declaration of Conformity

ZAXCOM, INC.
230 West Parkway, Unit 9
Pompton Plains, NJ 07444
September 1, 2015

We certify and declare under our sole responsibility that the following product:

TRXLA3, TRXLT3, TRX743 and TRX900CL wireless microphone transmitters
Restrictive use for residential, office and professional use only

Conforms with the essential requirements of the EMC Directive 2004/108/EC and
R&TTE Directive 99/5/EC, based on the following specifications applied:

- EN 300 422-2 v1.3.1 Radio Parameters
- EN 301 489-9 v1.4.1 Immunity
- EN 60950: 2006/A1:2011 Product Safety (low voltage directive)
- EN 50566: 2013 RF Exposure Safety

Our authorized representative in Europe is Mr. Roger Patel, Director of Everything
Audio located at Elstree Film Studios, Shenley Road, Borehamwood, Herts WD61JG in
England.

Glenn Sanders
President
Zaxcom, Inc.

Zaxcom, Inc.
230 West Prkwy, Unit 9
Pompton Plains, NJ
07444 USA

zaxcom.com
973.835.5000 (tel)
973.835.6633 (fax)